

Fecha _____ Alumno _____

Indica debajo de cada dibujo en que sistema se encuentra representado

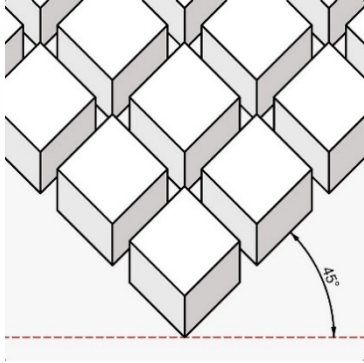

Perspectiva militar

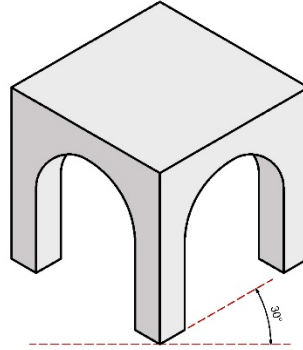

Perspectiva isométrica

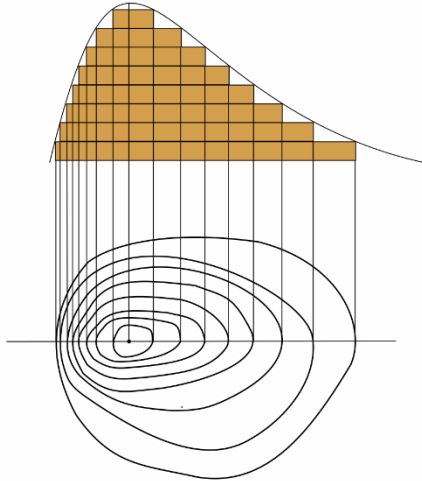

Sistema acotado

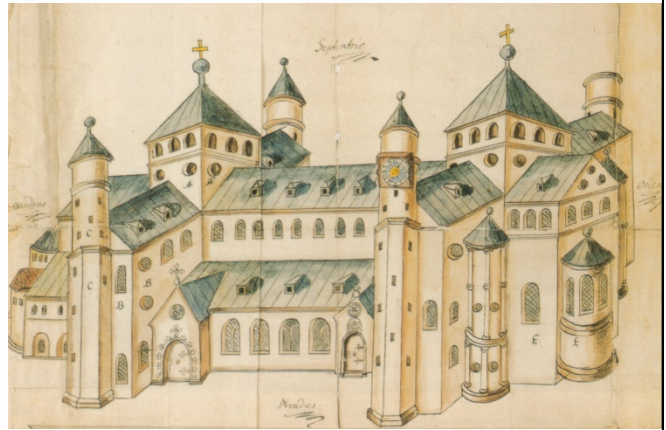

Perspectiva Caballera (aprox)

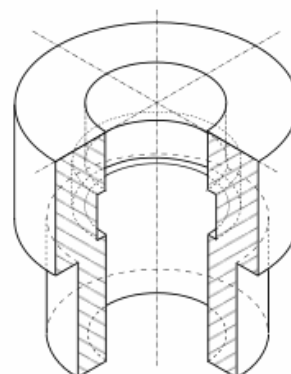
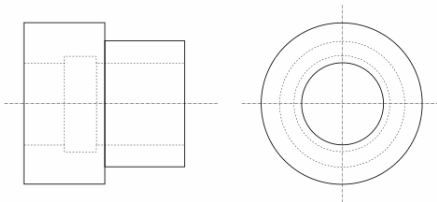

Perspective isométrique

Sistema diédrico

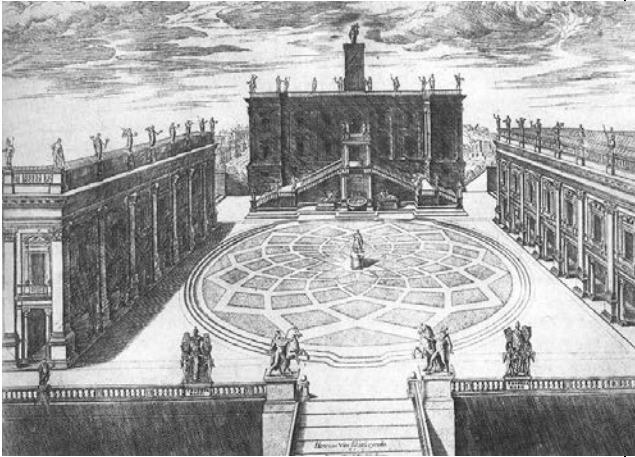

Perspectiva isométrica

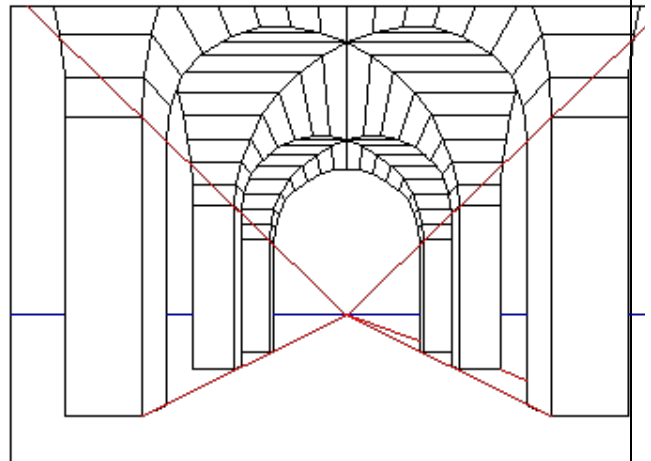

Perspectiva Cónica Frontal

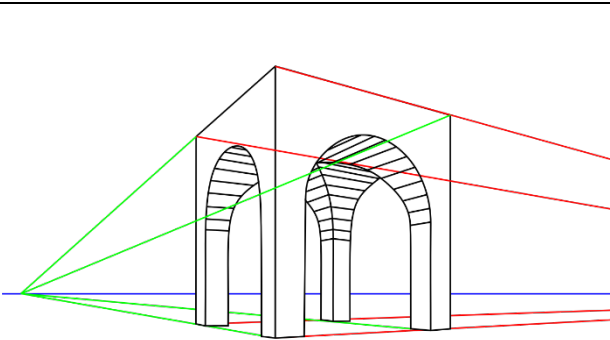

Perspectiva Cónica frontal

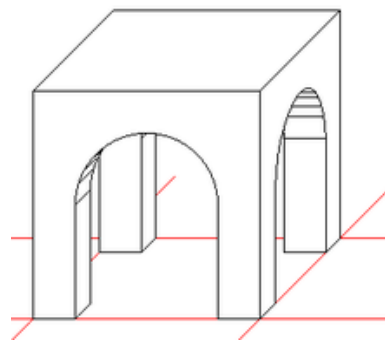

Perspectiva Cónica de dos puntos de fuga

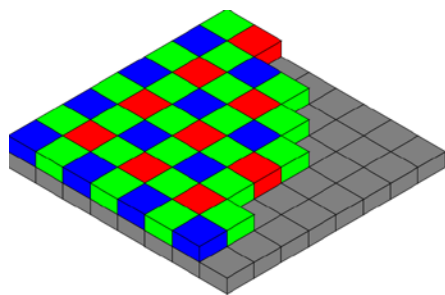

Perspectiva Caballera

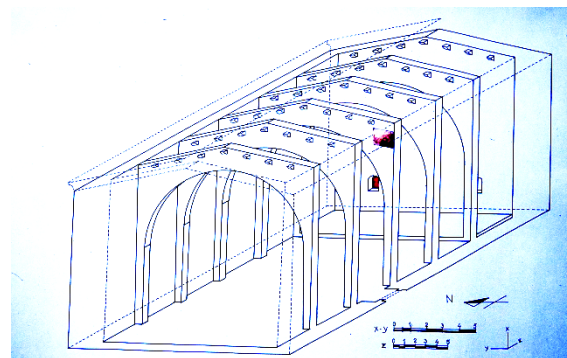

Perspectiva isométrica

Perspectiva Caballera